

Air Flow Company, Inc.

850 W. Fullerton Ave. • Addison, IL 60101
Tel (630) 628-1138 Fax (630) 628-1149

EA-744 7" Wind Driven, Sight Proof Stationary Louver

Standard Louver Construction

✓ Frame	Channel
✓ Frame Thickness	.081" extruded aluminum 6063-T5
✓ Blades Thickness	.081" extruded aluminum 6063-T5
✓ Fasteners	3/16" plated steel screw
✓ Screen	.050" x 3/4" expanded aluminum without frame
✓ Finish	Mill
✓ Undersized	1/4" under opening sizes
✓ Mullions	Invisible
✓ Minimum Size	12" x 12"
✓ Maximum Single Section	120" x 84" or 84" x 120"

Optional Construction

Frames	Channel .125" extruded aluminum 6063-T5
Blades	.125" extruded aluminum 6063-T5
Fasteners	Welded Construction Stainless Steel Fasteners
Screen	.063" x 1/2" wire mesh Bird Screen 18 x 16 Insect screen
Finish	Prime coat
	Baked enamel
	Powder coat
	Kynar 500 2 Coat 3 Coat Anodized Clear Color
Mullions	Visible
Frame Accessories	Flange
	Pan
	Extended sill

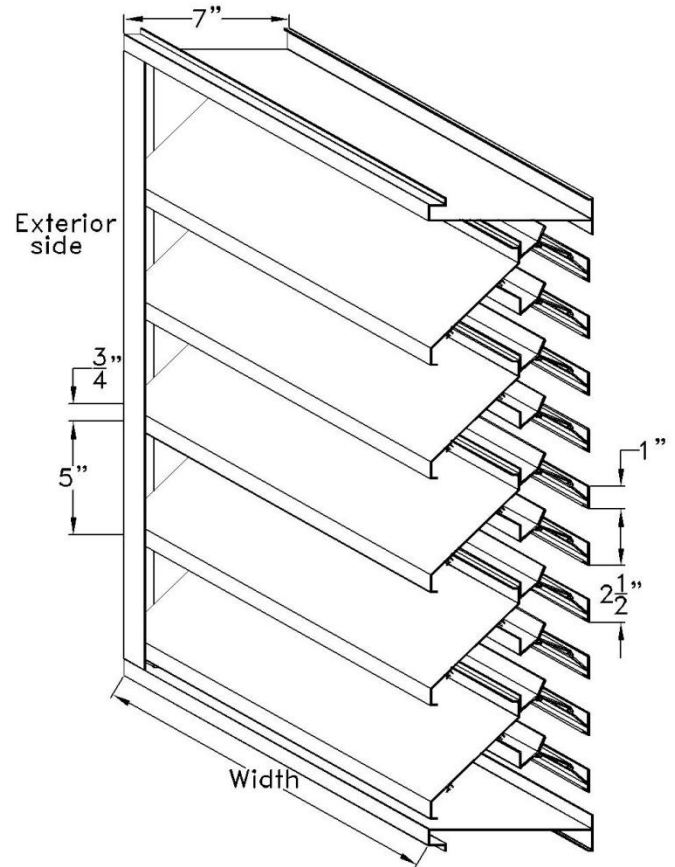

Air Flow Company Inc. certifies that the model: EA-744 louver shown herein is licensed to bear the AMCA Seal. The ratings shown are based on tests & procedures performed in accordance with AMCA Publication 511 and comply with the requirements of the AMCA Certified Ratings Program. The AMCA Certified Ratings Seal applies to water penetration and air performance ratings only. (Louver tested without bird screen)

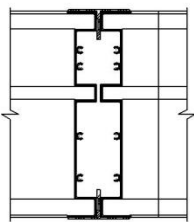

Exposed Mullion

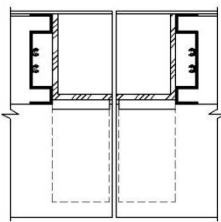

Invisible Mullion

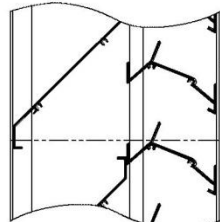

Hor. Invisible Mullion

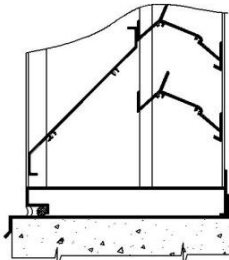

Channel W/sill

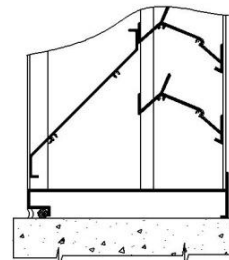

Channel Frame

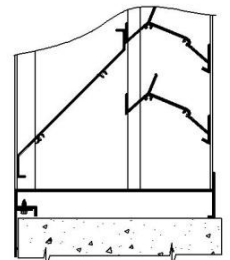

Flanged (1-1/2")

Louver Schedule

Item	Qty	Opening Size (W x H)	Notes	Project:
				Location:
				Arch/Eng:
				Customer:

Free Area Calculations (Sq. ft.)

		W I D T H (inches)														
		12	18	24	30	36	42	48	54	60	66	72	78	84	90	96
H E I G H T (inches)	12	0.40	0.64	0.88	1.12	1.36	1.60	1.85	2.09	2.33	2.57	2.81	3.05	3.29	3.54	3.78
	18	0.60	0.97	1.33	1.70	2.06	2.43	2.80	3.16	3.53	3.89	4.26	4.62	4.99	5.36	5.72
	24	0.81	1.30	1.79	2.28	2.77	3.26	3.75	4.24	4.73	5.22	5.70	6.19	6.68	7.17	7.66
	30	1.01	1.62	2.24	2.85	3.47	4.08	4.70	5.31	5.92	6.54	7.15	7.77	8.38	8.99	9.61
	36	1.22	1.95	2.69	3.43	4.17	4.91	5.64	6.38	7.12	7.86	8.60	9.34	10.07	10.81	11.55
	42	1.62	2.61	3.60	4.58	5.57	6.56	7.54	8.53	9.52	10.50	11.49	12.48	13.46	14.45	15.44
	48	1.83	2.94	4.05	5.16	6.27	7.38	8.49	9.60	10.72	11.83	12.94	14.05	15.16	16.27	17.38
	54	2.03	3.27	4.50	5.74	6.97	8.21	9.44	10.68	11.91	13.15	14.38	15.62	16.85	18.09	19.32
	60	2.24	3.60	4.96	6.32	7.67	9.03	10.39	11.75	13.11	14.47	15.83	17.19	18.55	19.91	21.27
	66	2.44	3.93	5.41	6.89	8.38	9.86	11.34	12.83	14.31	15.79	17.28	18.76	20.24	21.73	23.21
	72	2.85	4.58	6.31	8.05	9.78	11.51	13.24	14.97	16.71	18.44	20.17	21.90	23.63	25.37	27.10
	78	3.05	4.91	6.77	8.62	10.48	12.34	14.19	16.05	17.90	19.76	21.62	23.47	25.33	27.18	29.04
84	3.26	5.24	7.22	9.20	11.18	13.16	15.14	17.12	19.10	21.08	23.06	25.04	27.02	29.00	30.98	
90	3.46	5.57	7.67	9.78	11.88	13.99	16.09	18.20	20.30	22.40	24.51	26.61	28.72	30.82	32.93	
96	3.67	5.90	8.13	10.35	12.58	14.81	17.04	19.27	21.50	23.73	25.96	28.18	30.41	32.64	34.87	
102	4.08	6.55	9.03	11.51	13.99	16.46	18.94	21.42	23.89	26.37	28.85	31.33	33.80	36.28	38.76	
108	4.28	6.88	9.48	12.09	14.69	17.29	19.89	22.49	25.09	27.69	30.30	32.90	35.50	38.10	40.70	
114	4.49	7.21	9.94	12.66	15.39	18.11	20.84	23.56	26.29	29.02	31.74	34.47	37.19	39.92	42.64	
120	4.69	7.54	10.39	13.24	16.09	18.94	21.79	24.64	27.49	30.34	33.19	36.04	38.89	41.74	44.59	

Air Performance

Unit test size (48" x 48")
 Airflow rate at standard air density
 and the AMCA figure 5.5

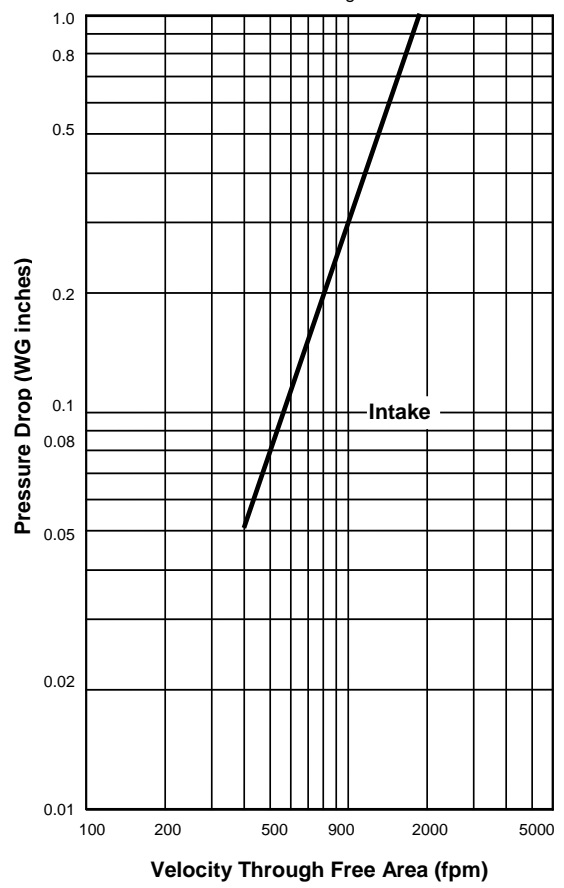

Air Flow Company Inc. certifies that the model: EA-744 louver shown herein is licensed to bear the AMCA Seal. The ratings shown are based on tests & procedures performed in accordance with AMCA Publication 511 and comply with the requirements of the AMCA Certified Ratings Program. The AMCA Certified Ratings Seal applies to water penetration and air performance ratings only.
 (Louver tested without bird screen)

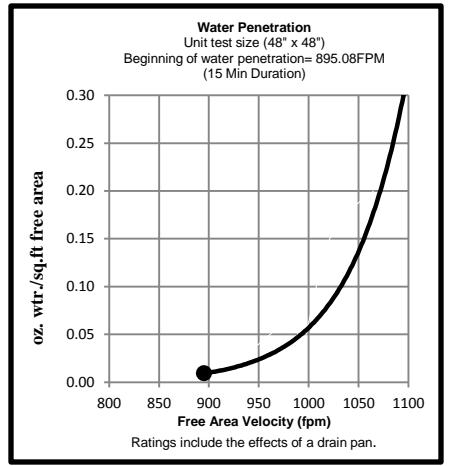

- ◆ To determine the pressure drop of a louver: Calculate the Velocity thru free area; divide the required CFM (volume of air) by the required free area chart above. The pressure drop is expressed in (inches w.g.)
- ◆ To determine the minimum free area required for louver: Divide the required CFM (volume of air) by the free area velocity before water penetration, then select the most desirable louver size from the free area chart above.
- ◆ To determine the maximum CFM (volume), knowing the louver size: Multiply the required free area (see free area chart above) by maximum velocity thru free area.